



HELIAS CATHOLIC

Helias Catholic High School is committed to providing excellence in education as established on the teachings of the Roman Catholic Church for students in grades 9-12. Working in partnership with families, we are dedicated to providing a disciplined environment where Christ and His graces in each person are recognized, respected and fostered. As a teaching institution in the traditions of the School Sisters of Notre Dame and the La Salle Christian Brothers, we challenge our students spiritually, academically and physically as we help form them to be active, lifelong, enthusiastic participants in the Church.

TABLE OF CONTENTS

Graduation Requirements	3
Grading System.....	5
English.....	6
Fine Arts	9
Foreign Language	14
Math	18
Physical Education	22
Practical Arts	24
Business.....	24
Science.....	31
Social Studies.....	36
Theology.....	40
Nichols Career Center.....	44
Dual Credit/AP Class Listing	45

GRADUATION OUTCOMES

A graduate of Helias Catholic will be prepared to:

- Participate as a lifelong, active, and enthusiastic member of the Church.
- Explain and defend the teachings of the Catholic Church.
- Write clearly and effectively for a variety of purposes.
- Assess and evaluate relevant and accurate information in both print and electronic forms.
- Use logical reasoning and problem solving for everyday life situations.
- Use relevant scientific concepts and procedures in daily life.
- Show an appreciation for cultural differences.
- Explain cause and effect relationships in various historical contexts.
- Participate as an active citizen in an interdependent world.
- Choose a healthy lifestyle based on respect for the body, proper nutrition, and physical fitness.
- Demonstrate an appreciation for the fine arts.
- Use technology appropriately and effectively.

❖ The courses marked as approved by the National College Athletic Association throughout this catalog, meet the standards for NCAA academic eligibility. Courses that are not marked with this approval are valid for graduation requirements. If you have questions about any athletic or academic eligibility, please contact your counselor.

GRADUATION REQUIREMENTS

Diligent and thoughtful planning will help Helias students maximize their educational experience during their four years as a Crusader. It is suggested that all freshman and sophomores take 7 credits including a credit in Theology. Juniors and seniors may take 6 to 7 credits, including a credit in Theology. Before selecting his/her course, each student should read the course descriptions carefully, noting the required and elective programs that will best prepare him/her for today and tomorrow. Students and families work in conjunction with the administration, counselors, and teachers to plan a rigorous course of study while at Helias Catholic.

In compliance with the Missouri Department of Elementary and Secondary Education, Helias requires 26 credits for graduation.

Subject	Helias Graduation Requirements	Typical College Admission Requirements
Theology	4 credits 1 credit per year	No credit required
English	4 credits 1 credit per year	4 credits
Mathematics	3 credits	4 credits Algebra I or higher
Science	3 credits	3 credits, one must be a lab
Social Studies	3 credits Civics .5 credits	3 credits
Physical Education	1 credit	
Health	.5 credit	
Foreign Language		2 credits in the same language
Fine Arts	1 credit	1 credit
Practical Arts	1 credit	
*Personal Finance or Consumer Ed.	.5 credit	
Electives	5.5 credits	

*Either Personal Finance OR Consumer Ed fulfills the graduation requirement.

Advanced Placement (AP) (10-12)

Advanced Placement courses (AP) are part of a program in the United States created by the College Board which offers college-level curricula and examinations to high school students. American colleges and universities may grant placement and course credit to students who obtain high scores on the examinations. AP courses are taught by Helias teachers during the regular school day. Students are not required to take an AP class in order to take an AP Exam, although it is highly recommended. Students may also take an AP course without taking an AP Exam. AP Exams are administered at Helias in May; the cost per exam is paid by the family.

Dual Credit (DC) (10-12)

Dual Credit courses (DC) are college level courses taught by Helias faculty for both college and high school credit. Through approval from local colleges and universities, Helias faculty teach the course in accordance with each college's approval. In order to earn college credit, students must meet the criteria of the accrediting university which include ACT qualifying scores (in some classes) and pay the established fees as set by each institution.

A full list of AP and Dual Credit courses offered by Helias is on the last page of this catalog.

Credit Recovery

If a student fails a class, the credit can be recovered in a number of ways. First, students can re-enroll in the class. Second, students can attend summer school if offered. Finally, in certain circumstances, students may be allowed to do online coursework to earn credit.

Student Accommodations

Helias is committed to assisting every student to grow academically, spiritually, and socially. We request all concerns regarding a student's challenges go through the Student Success Center. The Student Success Center team, in partnership with families, will determine the appropriate course of action to assist each child.

A+ Program (9-12)

A+ is a program funded by the State of Missouri. It provides scholarship funds to eligible graduates of A+ designated high schools who attend participating public community colleges. The A+ designation allows students to earn A+ scholarships so upon graduation they are more easily able to afford community college or other post-secondary education. In order to qualify students must meet the following guidelines:

- Be a U.S. citizen or permanent resident.
- Enter into a written agreement with your high school prior to graduation.
- 95 percent attendance (appeals can be made in cases of illness or injury)
- Students must perform at least 50 hours unpaid mentoring or tutoring (25 percent may include job shadowing)
- Maintain a record of good citizenship and avoid the unlawful use of drugs and/or alcohol. * Any infraction must be reported to the A+ Coordinator the next school day. Students who have an infraction are ineligible to apply.
- Students must have achieved a score of 17 on the math portion of the ACT
- Students must have at least a 2.5 grade point average.
- Must complete Federal Application for Student Financial Aid (that does not require repayment)
- Helias offers a class called Cadet Teaching to help students earn tutoring/mentoring hours during their study hall (listed on page 30 of the course catalog)

GRADING SYSTEM

Helias Catholic utilizes a quarterly grading system with each quarter consisting of nine weeks. Parents are encouraged to monitor their student's progress via the parent link on SIS. Grade point average (GPA) is based on a 4.00 point system. All subjects, including Nichols Career Center classes, are equally weighted in determining GPA.

Regular Grading Scale:			AP course grading scale:		
93 - 100	A	4.0	90 - 100	A	4.0
90 - 92	B+	3.7	87 - 89	B+	3.7
87 - 89	B	3.4	84 - 86	B	3.4
85 - 86	B-	3.0	80 - 83	B-	3.0
81 - 84	C+	2.7	77 - 79	C+	2.7
78 - 80	C	2.4	74 - 76	C	2.4
75 - 77	C-	2.0	70 - 73	C-	2.0
73 - 74	D+	1.7	67 - 69	D+	1.7
71 - 72	D	1.4	64 - 66	D	1.49
70	D-	1.0	60 - 63	D-	1.0
0 - 69	F	0	0 - 59	F	0

Semester grades are determined by using the raw (unrounded) percentages of the quarters and the semester exam. The quarters count for 40% each and the exam for 20%.

Two honor rolls are recognized: 'A' Honor Roll requires a grade point average of at least 3.833; 'B' Honor Roll requires a GPA between 3.00 and 3.832 with no grade lower than a C. All subjects, including Nichols Career Center, are considered in determining the honor rolls.

Helias Catholic is a non-ranking school, thus no student receives a class rank. The Valedictorian(s) represent the student(s) earning the highest GPA in the class; while also taking at least four full year AP courses.

ENGLISH DEPARTMENT

The English Department focuses instruction so students will:

- Demonstrate proficiency in literary history with an understanding of religious, moral, and social values relevant to a developing faith life.
- Communicate skillfully and effectively through print, visual, auditory, and technological media in the home, school, community and workplace.
- Implement research strategies using a variety of media, both electronic and print.
- Utilize critical thinking in the interpretation of literature.
- Develop various reading strategies to facilitate individual reading level/style.

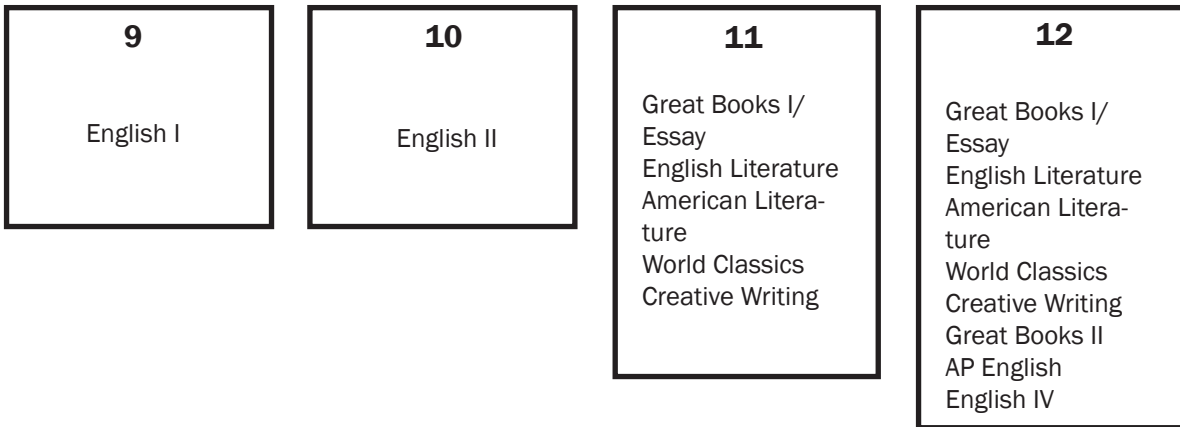

❖0202 English I

(Grade 9; 2 semesters; 1 credit)

Prerequisite: None

This course combines the study of literature, grammar, and composition. Composition skills will emphasize correct sentence structure and writing a unified, coherent essay. The class will collaborate with the school librarian to develop a library unit to develop competence in using the library facility and its materials with an emphasis in research while evaluating resource information. Students will gain the tools to allow them to gather textual evidence to support their thoughts. The class also focuses on grammar skills, sentence structure, and usage. The student will learn the terms, literary techniques, and backgrounds used in personal narratives, nonfiction pieces, short stories, Greek and Roman mythology, Shakespeare's *Romeo and Juliet*, and poetry.

❖0204 English II

(Grade 10; 2 semesters; 1 credit)

Prerequisite: None

In this course students will read short stories, essays, speeches, poetry, drama, and novels. Students will identify, analyze, and interpret plot, setting, characterization, narration, diction, figurative language, imagery, symbolism, and theme. Students will identify and analyze different types of poetry such as sonnets, ballads, and dramatic speeches, as well as identify and analyze major characteristics of drama. Students will demonstrate writing techniques in compositions and essays of analysis, interpretation, and evaluation. There will also be the opportunity for expansion of vocabulary and preparation for the English and Reading sections of the ACT.

❖Course is approved by the National College Athletic Association

❖0212 Great Books I/Essay

(Grade 11/12; 1 semester; .5 credit)

Prerequisite: None

Great Books I/Essay concentrates on reading classic works of literature from the Modern Period. Students will evaluate and discuss novels to determine and support a thesis statement and write a literary essay. Students will write argumentative and personal essays and work to improve writing skills, style, and essay structure. Students will also continue to improve their vocabulary and improve their ACT reading.

❖0214 Great Books II/Research Paper

(Grade 12; 1 semester; .5 credit)

Prerequisite: Completion of Great Books I/Essay

Great Books II/Research Paper is a college-preparatory course that concentrates on reading literary classics and learning the necessary skills for constructing an MLA-documented research paper. Students will apply research skills and will emphasize self-discipline in following directions, meeting deadlines, and implementing documentation. Students will analyze and discuss selected Modern Period novels.

❖0206 American Literature

(Grades 11/12; 1 semester; .5 credit)

Prerequisite: None

American Literature is a chronological study of American literature divided into historical ages and literary movements from Puritan to contemporary periods; authors include such people as Ben Franklin, Emily Dickinson, Edgar Allen Poe, Walt Whitman, and Robert Frost. Students will read a variety of genres such as historical documents, poetry, short stories, and drama. Students will be asked to respond to the literature in writing and will work to develop independent reading skills and maturity in analysis.

❖0210 English Literature

(Grades 11/12; 1 semester; .5 credit)

Prerequisite: None

English Literature is a chronological study of some of the great works in English literature. Works include Arthurian legend, *The Canterbury Tales*, Shakespeare's *Macbeth*, and modern short stories and poems. Students will be asked to respond in writing to literature and will work to develop independent reading skills and maturity in analysis.

❖0220 World Classics

(Grades 11/12; 1 semester; .5 credit)

Prerequisite: None

World Classics consists of a survey of literary works, including authors from ancient Greece to the modern period. Reading selections represent a variety of cultures from around the world. The course is designed to give students additional exposure to the essay, short story, poetry, drama, and the novel. Students will be asked to respond to the literature in writing and will work to develop independent reading skills and maturity in analysis.

❖0208 Creative Writing

(Grades 11/12; 1 semester; .5 credit)

Prerequisite: None

This course combines reading with writing as a means of self-expression and self-discovery. Students will create short stories, poems, movie scripts, prayers, and original characters. Studying novels and other writing stimulates imagination and provokes consideration of moral and ethical values requiring the student to search within for expression. Students are encouraged to view language with an artistic eye and cultivate it as a form of creative expression.

❖0224 AP English

(Grade 12; 2 semesters; 1 credit)

Prerequisite: Great Books I/Essay and instructor's signature. Students are required to bring their own laptop.

Dual Credit through Lincoln University.

ACT Score of 18 on English section required.

This course is an intensive study of literature and composition to prepare the advanced senior student. It demands skills in reading, writing, and thinking. It will include an intensive study of various genres of literature to develop close reading skills and a broad frame of reference of ongoing literary themes. Students will be expected to write frequently and practice essay skills. Students will learn the proper research methods. Summer reading is required.

❖0222 English IV

(Grade 12; 2 semesters; 1 credit)

Prerequisite: None

English IV is designed to develop a solid foundation of basic reading and writing skills. Students will practice effective note taking, improve vocabulary, and review basic skills. The course will address reading comprehension and practical writings used in daily life. Various genres will be used for enhancing comprehension and analysis of literature.

❖0226 Public Speaking

(1 semester; .5 credit)

Prerequisite: None

Dual Credit through Lincoln University.

Students must have passed ENG 101 (first semester of AP English) or have teacher recommendation for dual credit.

A study of interpersonal and public communication theory and practice. This diverse course is designed to develop knowledge and skills in the processes effective to all communication in diverse contexts.

FINE ARTS DEPARTMENT

The Fine Arts Department focuses instruction so that students will:

- Exercise creativity in the production of works in the area of design, graphic/ computer design, drawing, painting, music, and design composition and sculpture.
- Evaluate and critique works on the basic principles and elements of music, art, and design.
- Demonstrate proficient use of tools, technology, and materials related to specific area of study.
- Relate the characteristics of a work's particular style to a specific period in this history of music, art and design.
- Integrate spiritual, inspirational, personal, family, and cultural values in music, art, and design.

Other Information:

- The Fine Arts Department includes courses in Art, Music, and Drama.
- All students are required to earn 1 credit in the Fine Arts for graduation.

ART

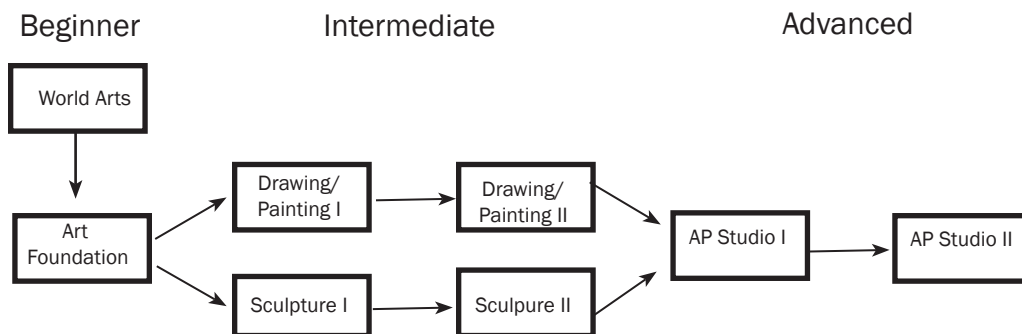

0632 World Arts

(Grades 9-12, 1 semester; .5 credits)

Prerequisites: None

World Arts cultivates student understanding of art history through analyzing works of art and placing them in historical context as they explore concepts like culture and cultural interactions, theories and interpretations of art, the impact of materials, processes, and techniques on art and art making, and understanding the purpose and audience in art historical analysis. Students will create artwork with connections to European, African, Pre-Columbian, and Asian cultures.

0634 Art Foundation (formerly Art I)

(Grades 9-12; 1 semester; .5 credit)

Prerequisite: None. If student has exemplary work from 8th grade, they may submit it for approval for Drawing/Painting I.

Art Foundation is the beginning course for all students who want to pursue an interest or future career in visual arts. Students will create original artwork in realistic, abstract, and nonobjective styles. Inspired by observation and imagination, they will express themselves through the themes of still life, landscape and portrait. They will use drawing, painting, and sculpture, to create two- and three-dimensional artworks. Students will analyze and critique artworks, discuss aesthetic issues, and understand how art is related to history and culture.

❖ Course is approved by the National College Athletic Association

0636 Drawing/Painting I (formerly Art II)

(Grades 10-12; 1 semester; .5 credit)

Prerequisite: Art I or Art Foundation

Students will develop technical skills in the use of drawing and painting media. They will create original, two-dimensional artworks based upon the themes of observation, expressive figure/portrait, architecture, landscape, still life, printmaking, and personal communication of an idea. Students will analyze and critique artworks, discuss aesthetic issues, and understand how art is related to history and culture.

0638 Drawing/Painting II (formerly Art III)

(Grades 10-12; 1 semester; .5 credit)

Prerequisite: Drawing/Painting I or Art II & Instructor's Approval (a suggested grade of B or better in Drawing/Painting I)

Students will develop advanced technical skills in the use of drawing media, watercolor and acrylic paint. They will create original two-dimensional artworks based upon the themes of perspective from observation, narrative art/historical documentation, reflection and transparency, the figure as a compositional element, printmaking techniques, and the development of a thematic idea through a series of related works. Students will analyze and critique artworks, discuss aesthetic issues and understand how drawing/painting evolved in the art history.

0640 Sculpture I

(Grades 11/12; 1 semester; .5 credit)

Prerequisite: Art I or Art Foundation with a grade of C or better recommended

Students will develop technical skills in the use of various media such as plaster, clay, paper, wire, and found objects. They will create original, three-dimensional artworks using modeling, carving, assemblage, and casting methods. Students will analyze and critique artworks, discuss aesthetic issues, and understand how art is related to history and culture.

0642 Sculpture II

(Grades 11/12; 1 semester; .5 credit)

Prerequisite: A grade of C or better in Sculpture I is recommended.

Students will learn to throw ceramic pieces on a potter's wheel and continue to develop hand-building and decorative surface techniques. They will create original functional and non-functional pieces. Students will express themselves through the themes of tile design, teapots, figurative ceramics, and vessel forms. Students will be inspired by ceramic pieces from ancient Greek, Asian, and contemporary American artists. Students will analyze and critique artworks, discuss aesthetic issues, and relate ceramic objects to the cultures in which they were created.

0644 AP Studio I or 1357 AP Studio II

(Grade 12; 2 semesters; 1 credit)

Prerequisite: Passing grade in three semesters of high school art including at least one advanced-level course. Portfolio reviewed and accepted by AP instructor.

The Advanced Placement Studio program enables highly motivated students to do college entry-level work in studio/3-D art. During the course, students will produce a portfolio of artworks that can be submitted to the College Board for AP credit. Some colleges also require portfolios works for admission and/or competitive scholarships. Students will create original artwork that demonstrates technical skills in a wide range of media through a variety of themes. They will also complete a concentration that consists of a body of work around a student-selected theme. Reflective writing is a significant part of the student's portfolio. Students are encouraged to submit a portfolio at the end of the year to the College Board.

❖ Course is approved by the National College Athletic Association

MUSIC

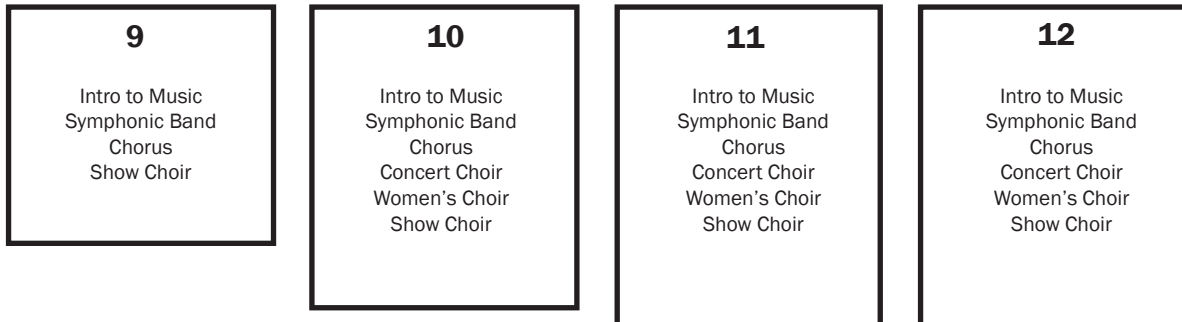

0602 Introduction to Music

(Grades 9-12; 1 semester; .5 credit)

Prerequisite: None

Introduction to Music is a non-performing course which explores the chronological development of music. The course will cover the basic elements of music and their developments, the stylistic musical periods and their influential composers with recognition of their music along with the historical, social, and economic conditions that influenced the developments of music in these periods.

0604 Symphonic Band

(Grades 9-12; 2 semesters; 1 credit)

Prerequisite: Middle school band or approval from Director of Bands

In Symphonic Band, students will continue to work on skills learned in middle school. Skills addressed will include: intonation, balance, blend, articulation, style, pulse control, rhythmic accuracy, and technical facility. This will be achieved through full ensemble, chamber groups, and possibly solo opportunities.

During fall semester, the band performs as the Marching Crusaders at home football games, community appearances, parades, and marching band contests. After football season, the band transitions to a concert band and presents at least 2 evening concerts per year in addition to the MSHSAA large ensemble contest held each spring. All students have the opportunity (but not a requirement) to perform in solos and chamber ensembles. Students who meet certain criteria are able to earn a varsity letter for their participation. Students interested in colorguard who do not play an instrument should register for the fall semester only of this course. 2 fall semesters of colorguard can fulfill a fine art credit requirement.

0606 Chorus

(Grades 9-12; 2 semesters, 1 credit)

Prerequisite: None/No Audition

Chorus is a full year course for students designed to provide an atmosphere for the enjoyment, appreciation, and performance of all types of choral music. This choir explores choral music from a wide variety of cultures and time periods through study and performance. The core curriculum emphasizes the basics of vocal technique, sight-reading, music theory, and music history. Students in Chorus are expected to participate in one evening concert each quarter and the State Music Festival as a major part of their grade.

❖ Course is approved by the National College Athletic Association

0608 Concert Choir

(Grades 10-12; 2 semesters, 1 credit)

Prerequisite: None/Audition

This year-long, upper-level performance ensemble is offered to students who are accomplished in vocal performance. Students will continue to develop vocal technique and musicianship, as well as develop critical thinking skills through the analysis of musical elements, including form and text, while continuing to study and perform choral music from a wide variety of cultures and time periods. Students are expected to participate in many performances throughout the year, including one evening concert each quarter and the State Music Festival.

0614 Music Theory

(Grades 11-12; 1 semester; .5 credit)

Prerequisite: Signature of Music Department instructor

This course is specifically geared to the serious music student and is intended for students with a desire to continue studying music in a college or university setting. Concepts taught will include: music notation, basic tonal harmony, chord and triad construction, melodic and rhythmic progressions, and part-writing rules of the common practice period. Basic aural skills such as interval recognition and an introduction to melodic, rhythmic, and harmonic dictation will also be discussed.

0612 Women's Choir

(Grades 10-12, 2 semesters, 1 credit)

Prerequisite: None/No audition

This is a year-long course offered to female students as continuation in the choral sequence. The core curriculum is a deeper exploration of vocal technique, music theory, and music history through the study of a wide variety of choral music written for women's voices. Students in Women's Choir are expected to participate in at least one evening concert each quarter and the State Music Festival as a major part of their grade.

0610 Show Choir

(Grades 9-12, 2 semesters, .5 credit)

Prerequisite: None/Audition

This is a year-long course offered to men and women interested in singing and dancing in a show of popular music styles. This choir also consists of a band made up of students playing keyboard, guitar, and drums. Students learn techniques of singing a variety of styles for stage performance, historical importance of the era of music performed, and a variety of dance styles. The ensemble rehearses before school and one evening per week. The show choir will participate in many performances throughout the year, including at least three competitions.

OTHER FINE ARTS

0520 Sociology of the Arts

(Grades 11-12; 1 semester; .5 credit)

Prerequisite: Instructor's signature required

This course is designed to help students understand how changes in art, music, literature, media, fashion, science and technology reflect the social, political, and economic trends of each decade from 1920-1980. This is a project-based course. Information for projects is gathered through individual and group research and through audio and video programs. It requires both independent and group work. Good time-management skills are necessary. This course may apply as either a Fine Art or Social Studies credit.

0724 Digital Design I

(Grades 10-12; 1 semester; .5 credit)

Digital Design I is an introduction to basic, entry-level skills of digital and graphic design. Students will be introduced to basic graphic design skills, digital publishing concepts and operations, layout of print and digital publications, decision-making activities, photo manipulation, and digital imaging. Students will develop the overall layout and production design for advertisements, brochures, and magazines (print and digital). Students will complete these activities with software such as the Adobe Creative Cloud Suite, commonly used in the digital publishing industry. The software emphasized will be Adobe Photoshop, Adobe InDesign, and Adobe Illustrator. This course may apply as either a Fine Art or Practical Art credit.

0728 Digital Design II

(Grades 10-12; 1 semester; .5 credit)

Prerequisite: Digital Design I

Digital Design II is advanced in nature from Digital Design I. Students will learn the advanced skills required for careers that focus on digital and graphic design. Students will learn the advanced features for the Adobe Creative Suite software including Photoshop, Illustrator, and InDesign. Students will be introduced to software programs Premiere Pro, After Effects and Dreamweaver. Premiere Pro and After Effects will allow for video editing, and Dreamweaver will focus on web design and web creation. This course may apply as either a Fine Art or Practical Art credit.

0730 Theater Design/Construction

(Grades 11-12; 1 semester; .5 credit)

Prerequisite: Signature of Design I instructor

Theater Design/Construction explores both the design and the construction aspects of theater sets. Students help with the actual design and construction of the sets for any theater productions that take place during the semester this course is taught. This course may apply as either a Fine Art or Practical Art credit.

0740 Computer Publications/Yearbook

(Grades 10-12; 2 semesters; 1 credit)

The Computer Publishing course produces Helias' yearbook. Students incorporate technical skills to utilize the online software, Yearbook Avenue and Layout Pro. Units of study include teamwork, responsibility, brainstorming, content, coverage, concept, reporting, writing, editing, photography, typography, design, graphics, finances, yearbook campaigns, advertising and distribution. Students are encouraged to take the course for the entire year, but exceptions will be made for semester enrollment.

❖ Course is approved by the National College Athletic Association

FOREIGN LANGUAGE

The Foreign Language Department focuses instruction so students will:

- Communicate at a level-appropriate ability in the areas of reading, writing, speaking, and understanding spoken language.
- Gain knowledge and understanding of other cultures to the extent that general patterns of behavior and ways of life are recognized and new insight into how language and culture shape world views.
- Connect with other disciplines as they develop the ability to acquire information and recognize distinctive viewpoints only available through foreign language and culture.
- Gain knowledge of and acceptance of diversity within our community and the world.
- Use level-appropriate language within and beyond the school setting and for personal enjoyment and enrichment, all while enhancing career options.

*For students who do not intend to complete four years of foreign language, it is entirely appropriate to take level 1 of a language either their freshman or sophomore year.

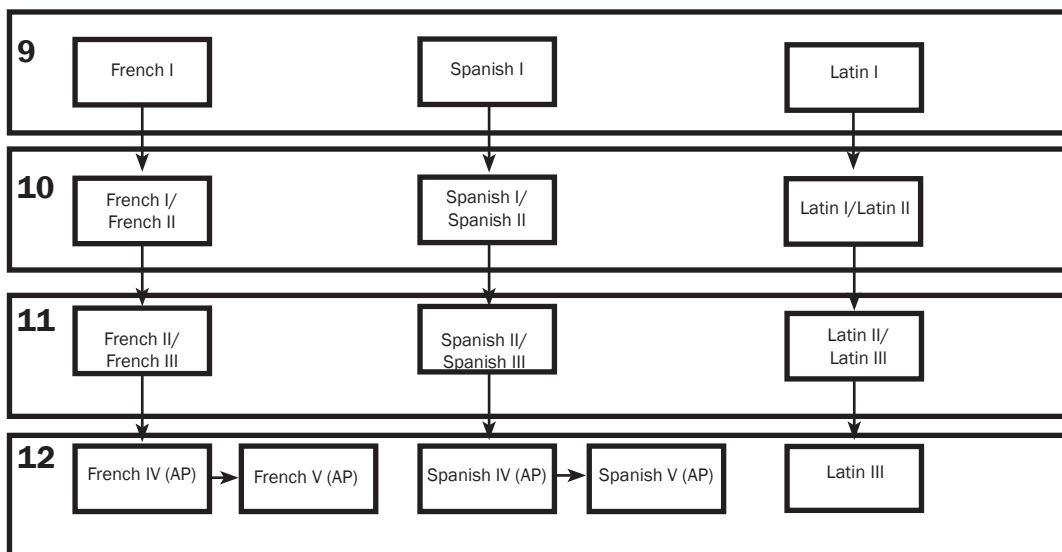

FRENCH

❖1002 French I

(Grades 9-12; 2 semesters; 1 credit)

Prerequisite: None

In French I students learn the basic skills of speaking, understanding, reading, and writing the French language. The course is designed to acquaint the student with the customs and daily life of French-speaking people as well as lead them to an understanding of the French-speaking world.

❖Course is approved by the National College Athletic Association

❖1004 French II

(Grades 10-12; 2 semesters; 1 credit)

Prerequisite: Minimum of 'C' in French I

French II students learn to further develop the student's skills in speaking, understanding, reading, and writing the French language. More emphasis is given to grammar and vocabulary expansion. Students are exposed to more of the culture of the people who speak the language and to their history.

❖1006 French III

(Grades 11-12; 2 semesters; 1 credit)

Prerequisite: Successful completion of French II

French III students learn to expand their knowledge and use of the language in speaking, understanding, reading, and writing. There is more emphasis on the mechanics of the language as well as literacy so the student becomes more capable in reading and responding to textual materials.

❖1008 AP French

(Grade 12; 2 semesters; 1 credit)

Prerequisite: Successful completion of French III.

Students are required to bring their own laptop.

AP French students continue to develop the grammatical knowledge and application of that knowledge in speaking, understanding, reading, and writing. Special emphasis is given to vocal communication in addition to the practice with textual materials. At the end of this course, the student may elect to take the AP French Language and Culture exam for college placement.

1010 AP French Literature – Independent Study

(Grade 12; 2 semesters; 1 credit)

Prerequisite: Consent of Instructor and Administration.

Students are required to bring their own laptop.

AP French Literature places special emphasis on literature, grammar, and teaching the lower levels of French. This course is an independent study and is specific to the individual student.

SPANISH

❖1020 Spanish I

(Grades 9-12; 2 semesters; 1 credit)

Prerequisite: None

This course, which is designed for first-year students of Spanish, offers an introduction to the Spanish language and the many cultures it encompasses. Your coursework will allow you to develop all four language skills: reading, writing, speaking, and listening, along with the cultural background necessary to help you to communicate effectively in Spanish.

❖1022 Spanish II

(Grades 9-12; 2 semesters; 1 credit)

Prerequisite: Spanish I

This course, which is designed for 2nd year students of Spanish, offers further studies of the Spanish language and the many cultures it encompasses. Your coursework will allow you to develop all four language skills: reading, writing, speaking, and listening along with the cultural background necessary to help you to communicate effectively in Spanish.

❖1024 Spanish III

(Grades 10-12; 2 semesters; 1 credit)

Prerequisite: Minimum grade of "C" in Spanish II

This course, which is designed for 3rd year students of Spanish, offers further studies of the Spanish language and the many cultures it encompasses. Your coursework will allow you to develop all four language skills: reading, writing, speaking, and listening along with the cultural background necessary to help you to communicate effectively in Spanish.

❖1026 AP Spanish IV

(Grades 11-12; 2 semesters; 1 credit)

Prerequisite: Minimum grade of "C" in Spanish III.

Students are required to bring their own laptop.

This course, designed for the fourth year student of Spanish expands upon the listening, speaking, reading and writing skills developed during the first three years of Spanish. At this point, all grammatical structures have been covered and a base vocabulary has been established. Spanish IV focuses on putting this grammar and vocabulary into practice through the 6 themes of AP Spanish Language and Culture.

1028 AP Spanish V

(Grade 12; 2 semesters; 1 credit)

Prerequisite: Successful completion of AP Spanish IV and instructor's approval.

Students are required to bring their own laptop.

Having completed four years of Spanish, the students in AP Spanish V will focus on Spanish Literature. Through critical reading and analytical analysis of major Spanish works of literature, the AP Spanish V student will have prepared themselves for success in college level Spanish courses.

LATIN

❖1012 Latin I

(Grades 9-12; 2 semesters; 1 credit)

Prerequisite: None

Latin I is an introduction to the grammar of the language of the ancient Romans and is intended to provide the fundamental skills to begin translation of Latin text. Students will learn Latin grammar, vocabulary, and syntax in order to translate basic Latin text, while improving their knowledge of English grammar, vocabulary, spelling, and ancient Roman history. Classes will consist of the study of Latin grammar, translation exercises, weekly vocabulary quizzes, and class discussion of periodic assignments. Latin not only contributes greatly to the formation of a student's faith, but is critical for development in all phases of learning.

❖1014 Latin II

(Grades 10-12; 2 semesters; 1 credit)

Prerequisite: Latin I

Latin II completes the introduction to the grammar of the Latin language, and provides all skills for the translation of Latin text. Students will complete the Latin grammar, vocabulary, and syntax in order to translate Latin text, while improving their knowledge of English grammar, vocabulary, spelling, and ancient Roman history. Classroom activities will consist of the study of Latin grammar, translation exercises, weekly vocabulary quizzes and discussion of periodic assignments. Latin not only contributes greatly to the formation of a student's faith, but is critical for development in all phases of learning.

❖1016 Latin III

(Grades 11-12; 2 semesters; 1 credit)

Prerequisite: Latin II

Latin III students will apply the grammar, vocabulary, and syntax learned in Latin I and Latin II by reading upper level texts such as the Vulgate, Caesar's Gallic Wars, and Vergil's Aeneid. In the course of reading these texts, students will review grammar and syntax from alternate sources, and they will expand their knowledge of Latin vocabulary through weekly quizzes.

MATHEMATICS DEPARTMENT

The Math Department focuses instruction so students will:

- Use logical reasoning and problem solving for everyday lifesituations.
- Add, subtract, multiply, and divide rational numbers.
- Use methods of individual and collaborative problem solving and decision making.
- Use technology resources to research and solve problems.
- Recognize geometric shapes and understand the properties that apply to the shapes.

Other Information:

- All students are required to earn 3 credits in Mathematics for graduation.

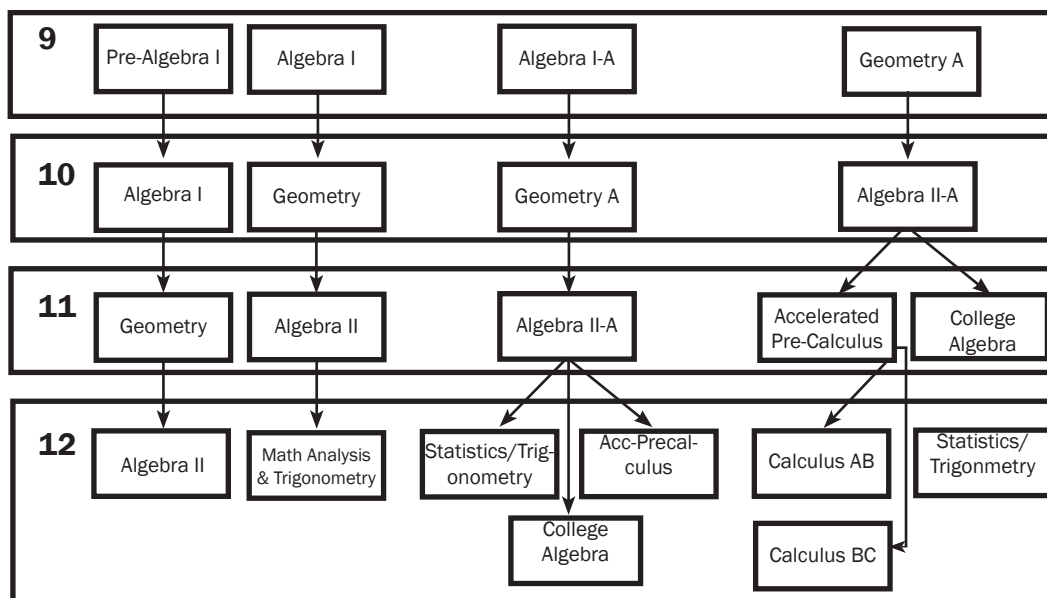

0302 Pre-Algebra

(Grade 9; 2 semesters; 1 credit)

Prerequisite: Counselor's approval and signature

In Pre-Algebra students will review skills in multiplication, division, subtraction, and addition. This course is taught with an intuitive approach to the study of these skills through problems related to everyday life, activities, and graphs. Also included is a basic study of probability and statistics using probability proportion. Students will work on developing their ability to estimate answers and measurements, as well as work with simple algebraic equations, metric systems, integers, fractions, decimals, equations, and inequalities. Students completing Pre-Algebra will be expected to move to Algebra I.

❖0304 Algebra I

(Grades 9–10; 2 semesters; 1 credit)

Prerequisite: 8th-grade standardized test scores

This course is an introduction to Algebra. Topics covered are properties of real numbers, solving equations and inequalities, and systems of equations relations. Graphs, polynomials, factors and rational expressions, irrational numbers, radicals, and quadratic equations are also covered. Material is presented with more time for classroom help and review than Algebra I A. Axioms and proofs are not included.

❖0306 Algebra I A

(Grades 9-10; 2 semesters; 1 credit)

Prerequisite: 8th-grade standardized test scores

This course is an introduction to Algebra. Topics covered are properties of real numbers, solving equations and inequalities, and systems of equations relations. Graphs, polynomials, factors and rational expressions, irrational numbers, radicals, and quadratic equations are also covered.

❖0308 Geometry

(Grades 10-11; 2 semesters; 1 credit)

Prerequisite: Algebra I-A or Algebra I

Geometry is an introduction to a deductive mathematical system. Students will learn spatial visualization, working with lines and figures in a plane, theorems, the relation of parallel and perpendicular lines, finding area and volume of three-dimensional figures, and similar and congruent triangles. Geometric constructions using straight edge and compass are also covered. Material is presented with more time for classroom help and review than Geometry A.

❖0310 Geometry A

(Grades 9-11; 2 semesters; 1 credit)

Prerequisite: C average in Algebra I-A or in Algebra I with Instructor's approval

Geometry A is an introduction to a deductive mathematical system. Students will learn spatial visualization, working with lines and figures in a plane, theorems and their proofs, the relation of parallel and perpendicular lines, and similar and congruent triangles, finding area and volume of three-dimensional figures. Geometric constructions by using straight edge and compass are also covered.

❖0314 Algebra II

(Grades 11-12; 2 semesters; 1 credit)

Prerequisite: Completion of Algebra I and Geometry

Algebra II is designed to further student's algebraic knowledge from Algebra I. Algebra II stresses both the structure of algebra and the development of computational skills. Topics include fraction review, linear functions and relations, systems of linear equations and inequalities, functions, quadratics, polynomials, rational expressions, radicals, irrational numbers, and exponents. Material is presented with more time for classroom help and review than Algebra II A.

❖0324 Math Analysis and Trigonometry

(Grade 12; 2 semesters; 1 credit)

Prerequisite: Algebra II

In Math Analysis and Trigonometry, students will expand on the topics of Algebra II and learn about graphing, probability, statistics, exponential functions, logarithms, trigonometry, rational and radical expressions, systems of non-linear, critical thinking and problem solving.

❖0312 Algebra II A

(Grades 10-12; 2 semesters; 1 credit)

Prerequisite: at least a C average in Geometry A, or special permission from math instructor

Algebra II A is designed to further student's algebraic knowledge from Algebra I. Students are introduced to the complex number system, exponential functions, logarithms, and trigonometry. Algebra II A both stresses the structure of algebra and the development of computational skills. Topics include: linear functions and relations, systems of linear equations and inequalities, matrices and determinants, polynomials, rational expressions, radicals, irrational numbers, exponents, trigonometric functions, identities, and formulas.

❖0318 Statistics & Trigonometry

(Grades 11-12; 2 semesters; 1 credit)

Prerequisite: Algebra II-A or Algebra

Dual credit through Lincoln University (6 hrs).

A study of the trigonometric functions including graphing, identities, solutions of trigonometric equations and solution of triangles. Descriptive and inferential statistics including frequency distributions, measures of central tendency and variation, probability and sampling distributions, tests of hypothesis, confidence intervals, linear correlation and regression. Graphing calculator required.

❖0316 College Algebra

(Grades 11-12; 2 semesters; 1 credit)

Prerequisite: C average in Algebra II A and with Instructor's signature

Lincoln University math placement test with score of 33 or Math ACT score of 22 required.

Dual credit through Lincoln University.

Pre-calculus is an introduction to mathematical analysis with additional math logic. Students will be introduced to sequences and series--both finite and infinite. This course covers an advanced study of higher degree equations and functions and relations including different methods of equation-solving of upper degree functions. It further studies the exponential and logarithmic and trigonometry.

❖0322 Accelerated Pre-Calculus

(Grades 11-12; 2 semesters; 1 credit)

Prerequisite: Math Instructor's signature.

Lincoln University math placement test with score of 33 or Math ACT score of 22 required.

Students are required to bring their own laptop.

Dual credit through Lincoln University.

Accelerated Pre-Calculus is offered as a 5 dual credit hour course through Lincoln University. Course content includes properties of functions, solving higher-order equations, trigonometry, logarithms, exponential functions, conic sections, basic probability and summations, and problem solving. After completion of this course students will be prepared to take Calculus I.

❖0326 AP Calculus AB

(Grade 12; 2 semesters; 1 credit; available for college credit)

Prerequisite: Pre-calculus, and/or Accelerated Pre-Calculus, and instructor's signature.

Students are required to bring their own laptop.

Dual credit through Lincoln University (5 hrs).

Advanced Placement Calculus AB is college-level Calculus I. Students will be prepared to take the AP Calculus test in May, or they have the option to take Calculus I as a 5 dual credit hour course through Lincoln University. Course content includes properties of functions, limits and continuity, differentiation, integration, as well as theorems and applications of calculus I concepts. After completion of this course students will be prepared to take Calculus II.

❖0328 AP Calculus BC

(Grade 12; 2 semesters; 1 credit; available for college credit)

Prerequisite: A grade of 'C' or higher in Accelerated Pre-calculus and instructor signature.

Students are required to bring their own laptop.

Dual credit through Lincoln University (10 hrs) .

Advanced Placement Calculus BC is college-level Calculus I and Calculus II. Students will be prepared to take the AP Calculus test in May, or they have the option to take Calculus I as a 5 dual credit hour course through Lincoln University during first semester and Calculus II as an additional 5 credit hours during second semester. Calculus I course content includes properties of functions, limits and continuity, differentiation, integration, as well as theorems and applications of calculus I concepts. Calculus II course content includes further applications of derivatives and integration, infinite series, Taylor Series, parametric and polar equations. After completion of this course students will be prepared to take Calculus III.

PHYSICAL EDUCATION DEPARTMENT

The Physical Education Department focuses instruction so students will:

- Pursue a healthy lifestyle using a basic knowledge of hygiene, nutrition, fitness, and mental health.
- Participate regularly in various lifetime sports and physical fitness activities.
- Show evidence of an appreciation of outdoor activity and of the ability to use the appropriate skill sets.

Other Information:

- All students are required to earn .5 Health credit for graduation.
- All students are required to earn 1 Physical Education credit for graduation.

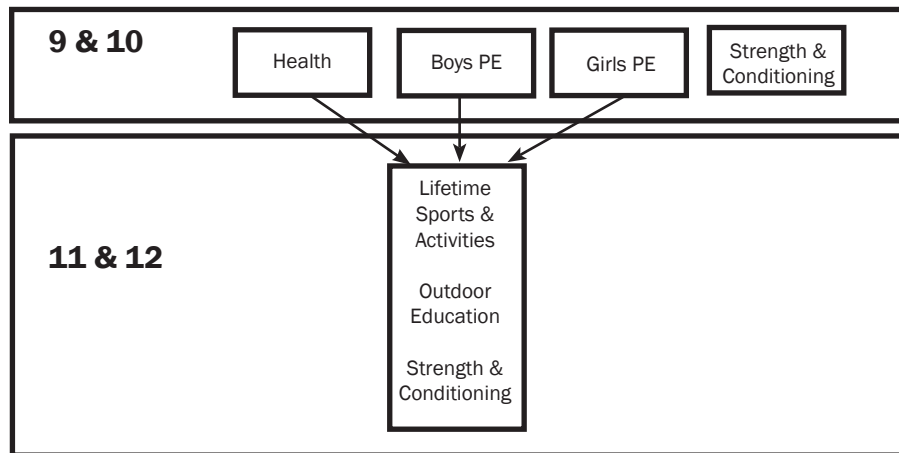

0802 Boys' Physical Education

(Grades 9-10; 1 semester; .5 credit)

Prerequisite: None

Physical education for freshman and sophomore boys is designed to introduce a variety of team sports and individual activities intended to improve each student's personal physical fitness. Along with the games, there is a heavy emphasis on strength, agility, flexibility, and aerobic training--all designed to help the student improve his overall level of fitness.

0804 Girls' Physical Education

(Grades 9-10; 1 semester; .5 credit)

Prerequisite: None

Physical education for freshman and sophomore girls is designed to introduce a variety of team and individual activities intended to improve each student's personal physical fitness. Along with games, there is an emphasis on strength, agility, flexibility and aerobic training – all designed to help the student improve her overall level of fitness.

0902 Health

(Grades 9-10; 1 semester; .5 credit)

Prerequisite: None

Health is designed to acquaint each student with a variety of health information to enable them to develop good health habits. Subject matter will include information and class discussions, and will require a research paper at the end of the semester. The goal of this class is to help students identify where they fit in the continuum of wellness, and how to make responsible, healthy decisions while shaping proper attitudes towards personal health care.

0808 Lifetime Sports and Activities

(Co-ed; Grades 11-12; 1 semester, .5 credit)

Prerequisite: None

Lifetime Sports and Activities is designed to introduce each student to a variety of individual and dual sports as well as activities to improve the student's skill and cardiovascular conditioning. Along with games, there is a heavy emphasis on sportsmanship, strategy, development, and enjoyment -all designed to help the student improve his/her level of fitness.

0810 Outdoor Education

(Co-ed; Grades 11-12; 1 semester, .5 credit)

Prerequisite: None

Outdoor Education is designed to introduce students to a variety of outdoor activities to create an appreciation and understanding of outdoor activities. By studying and practicing the skills associated with the activities, students will improve their understanding of the correct and safe way to be active in the outdoors.

0806 Strength and Conditioning

(Grades 9-12; 1 semester; .5 credit)

Prerequisite: None

In Strength and Conditioning students will learn how to perform basic and complex Strength and Conditioning movements and exercises. The students will work to increase their strength, conditioning, agility, and appreciation of skills needed for their sport, as well as, skills to be able to operate in a recreational setting on their own. There will also be an emphasis on changing the body composition through proper diet and education. Each student will be graded on their understanding of techniques, safety procedures, and overall effort.

0812 Fitness 101

(Co-ed; Grades 10-12; 1 semester, .5 credit)

Prerequisite: None

An alternative to weight training, this course will introduce students to a variety of exercises which will condition the body and relieve stress. Examples include: Pilates, yoga, kickboxing, dance, walking, hiking, biking, stretching and meditation.

PRACTICAL ARTS DEPARTMENT

The Practical Arts Department focuses instruction so students will:

- Exercise creativity in the production of works in the area of design, graphic/computer design.
- Manifest a proficiency in the use of tools, technology, and materials related to the particular area of study.

Other Information:

- All students are required to earn 1 credit in a practical art, any business or technology class fulfills this requirement.

BUSINESS

The Business Department focuses instruction so students will:

- Effectively manage personal finances.
- Apply technology to analyze, synthesize, and evaluate situations at home, school, and work.
- Know how to use employment resources.
- Practice skills to become an informed citizen, wise consumer, and a producer of goods and services.
- Differentiate between ethical and unethical decisions in the workplace, at school, or at home.
- Students are required to take Personal Finance as a graduation requirement. Consumer Education can replace this requirement.

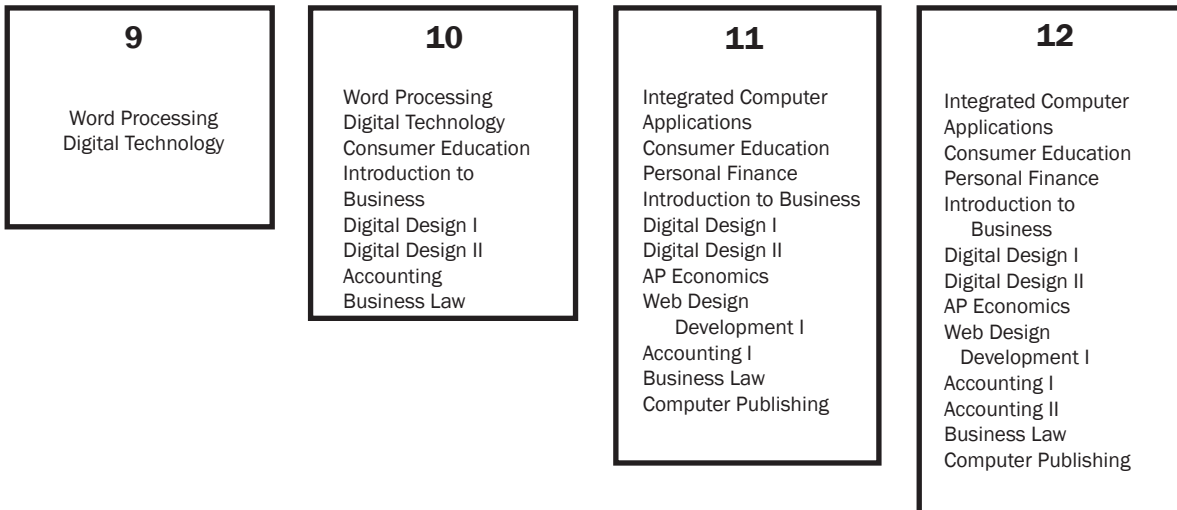

0704 Word Processing

(Grades 9-12; 1 semester, .5 credit)

Prerequisite: None

Word Processing is a beginning level computer course. Improving/learning the alphabetic keyboard as well as speed and accuracy will be emphasized throughout the semester. The curriculum will include formatting business documents such as reports, letters, tables, and memorandums. Utilizing the menu tabs and ribbon features will be emphasized in detail within this course.

0708 Digital Technology

(Grades 9-12; 1 semester, .5 credit)

Prerequisite: None

The Digital Technology class is designed to prepare students to utilize technology for academic and business purposes. A thorough study of technology ethics and protection will be emphasized. The course will include digital citizenship and literacy. Students will complete a variety of projects using different programs displaying their skills as a twenty-first century learner. This course is designed to aid students to be successful in the work world and academic setting.

0746 Web Design Development I

(Grades 11-12; 1 semester; .5 credit)

Prerequisite: College Algebra and signature of math instructor

Web Design Development I serves as an introduction to the design, creation, and maintenance of web pages and websites. This course teaches basic coding of web pages, including HTML, CSS, and JavaScript. The course progresses from introductory work on web design to a culminating project in which students design and develop a website for a club or team at Helias.

0724 Digital Design I

(Grades 10-12; 1 semester; .5 credit)

Prerequisite: None

Digital Design I is an introduction to basic, entry-level skills of digital and graphic design. Students will be introduced to basic graphic design skills, digital publishing concepts and operations, layout of print and digital publications, decision-making activities, photo manipulation, and digital imaging. Students will develop the overall layout and production design for advertisements, brochures, and magazines (print and digital). Students will complete these activities with software such as the Adobe Creative Cloud Suite, commonly used in the digital publishing industry. The software emphasized will be Adobe Photoshop, Adobe InDesign, and Adobe Illustrator. This course may apply as either a Practical Art or Fine Art credit.

0728 Digital Design II

(Grades 10-12; 1 semester; .5 credit)

Prerequisite: Digital Design I

The Digital Design II course is advanced in nature from Digital Design I. Students will learn the advanced skills required for careers that focus on digital and graphic design. Students will learn the advanced features for the Adobe Creative Suite software including Photoshop, Illustrator, and InDesign. Students will be introduced to the software programs Premiere Pro, After Effects and Dreamweaver. Premiere Pro and After Effects will allow for video editing, and Dreamweaver will focus on web design and web creation. May apply as either a practical art or a fine art credit.

0740 Computer Publications/Yearbook

(Grades 10-12; 2 semesters; 1 credit)

Prerequisite: None

The Computer Publishing course produces Helias' yearbook. Students extensively incorporate technical skills to utilize the online software, Yearbook Avenue and Layout Pro. Units of study include teamwork, responsibility, brainstorming, content, coverage, concept, reporting, writing, editing, photography, typography, design, graphics, finances, yearbook campaigns, advertising and distribution. Students are encouraged to take the course for the entire year, but exceptions will be made for semester enrollment. This course may apply as either a Practical Art or Fine Art credit.

❖ Course is approved by the National College Athletic Association

0736 Integrated Computer Applications

(Grades 11-12; 1 semester; .5 credit)

Prerequisite: Word Processing or Digital Technology with Instructor Signature required.

Students are required to bring their own laptop.

Dual credit through Lincoln University

Integrated Computer Applications is a college level course for students to learn how to create professional documents in the integrated applications of word processing, database, spreadsheets, presentation graphics, and other applications pertinent to business. Upon completion of this course, the student should have an understanding of which software application is most efficient for the situation and have a thorough understanding of terminology related to the applications.

0720 Consumer Education

(Grades 10-12; 1 semester; .5 credit)

Prerequisite: None

Consumer Education is designed to enable the student to become a wise consumer. Students will have a better understanding of the consumer's role in the economy. In the course, students will look at the factors that help a consumer make economically sound decisions in the areas of purchasing, budgeting, using credit, borrowing, saving, investing, sharing economic risks, and using natural resources. This course fulfills the Personal Finance graduation requirement.

0732 Introduction to Business

(Grades 10-12; 1 semester; .5 credit)

Prerequisite: None

Introduction to business will introduce students to the world of business and help them prepare for the economic roles of consumer, worker, and citizen. The course will explain the importance of the decision-making process and help them prepare for future employment. Topics discussed include the economic system of the United States versus other nations' systems, business structures (partnerships, corporations, franchises), managerial styles, marketing techniques, and technology advances in business.

0716 Business Law

(Grades 10-12; 1 semester; .5 credit)

Prerequisite: None

Students will explore the foundations of business and personal law. Coverage will include contracts, criminal law, consumer protection, property law, ethics, and various court systems. The students will complete case studies and debates in addition to textbook work.

0742 Personal Finance

(Grades 11-12; 1 semester; .5 credit)

Prerequisite: None

This course will enable students to make sound financial decisions in their personal lives. The course is designed to address a variety of learning styles. Learning will occur through lecture, audio CDs, videos, independent reading, and hands-on activities. The course is divided into four units: Income, Money Management, Spending/Credit and Saving/Investing.

0744 AP Economics

(Grades 11-12; 2 semesters, 1 credit)

Prerequisite: A or B in Geometry A

This course is designed to prepare students for the AP Economics Exam. The AP course is divided into two distinct parts: microeconomics (scarcity, price determination, the theory of the firm, externalities) in the first semester and macroeconomics (public finance, fiscal and monetary policy, inflation, unemployment, economic growth, international trade) in the second semester. Emphasis is placed on critical thinking skills through the understanding, application, and analysis of fundamental economic concepts. This course requires significant work outside of class and during the summer leading into the course.

0712 Accounting I

(Grades 10-12; 2 semesters; 1 credit)

Prerequisite: Signature of Accounting Instructor required/Purchase workbook from school bookstore

Accounting I is the initial course to help the student develop an understanding of financial transactions with the ability to record, present, and interpret these transactions. Students are introduced to the combination journal, special journal, general ledger, subsidiary ledgers, and accounting for the microcomputer. One practice set is completed which shows the students in a more realistic manner the handling of business vouchers such as checks, invoices, statements, memos, etc . Values of fairness and honesty in business are stressed.

0734 Accounting II

(Grades 11-12; 2 semesters; 1 credit)

Prerequisite: Accounting I and Signature of Accounting I Instructor required/Purchase workbook from school bookstore

Accounting II is the advanced course to help students further develop their understanding of accounting transactions. Corporate accounting, cost accounting, departmentalized, and management accounting is the focus of this year-long course. One practice set is completed which shows the students in a more realistic manner the handling of business forms, statements, checks, and reports. Values of fairness and business ethics are stressed.

DESIGN/DRAFTING

The Design / Drafting curriculum area consists of Design and Construction I,II and III, Mechanical Drawing and Theater Design. Design and Construction will explore the layout for both commercial and residential designs. Mechanical Drawing will be an introduction to the drafting world with isometric, three view, auxiliary and section view drawings. Theater Design will be more hands on with basic designs and the construction as well as special painting and effects of theater sets.

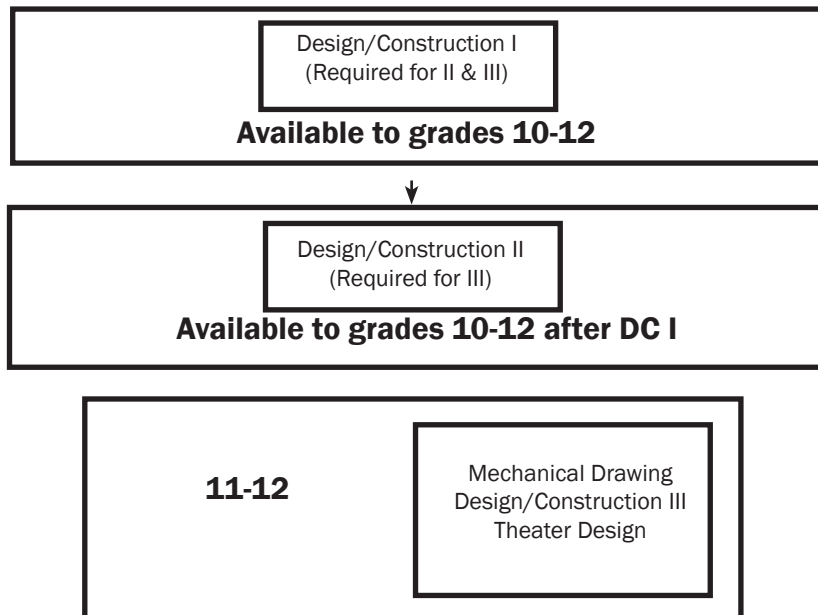

0714 Design/Construction I

(Grades 10-12; 1 semester; .5 credit)

Prerequisite: Purchase Design and Construction Drafting Kit from school bookstore

Design and Construction I is an introduction to the fields of architecture. Information is given by the instructor to help students design and draw a set of working drawings for residential homes.

0718 Design/Construction II

(Grades 10-12; 1 semester; .5 credit)

Prerequisite: Design/Construction I and Instructor's approval.

Purchase Design and Construction Drafting Kit from school bookstore.

The students will continue in the field of architecture, but more emphasis will be placed on design problems. Besides residential designs, other areas studied will be commercial designs as well as professional building designs and materials.

0722 Design/Construction III

(Grades 11-12; 1 semester; .5 credit)

Prerequisite: Design and Construction I and II/Instructor's approval.

Purchase Design and Construction Drafting Kit from school bookstore.

The student will continue to study the field of residential architecture with emphasis on size problems and creativity. The students will also be researching the cost of building materials, cabinets, doors, windows, appliances, fixtures, and more.

❖ Course is approved by the National College Athletic Association

0730 Theater Design/Construction

(Grades 11-12; 1 semester; .5 credit)

Prerequisite: Signature of the Design I Instructor

Theater Design/Construction explores both the design and the construction aspects of theater sets. Students help with the actual design and construction of the sets for any theater productions that take place during the semester this course is taught. May apply as either a practical art or a fine art credit.

0726 Mechanical Drawing

(Grade 11 -12; 1 semester; .5 credit)

Prerequisite: Instructor's approval.

Purchase Mechanical Drawing Drafting Kit from school bookstore

Mechanical Drawing is a good fundamental study of multi-view drawing, isometric projection, auxiliary views, and section drawings. It will enable the student to develop good drafting techniques along with the basic knowledge needed for one who plans to go into drafting or engineering.

OTHER

0620 Speech/Drama I

(Grades 9-10; 1 semester; .5 credit)

Prerequisite: None

This course stresses the importance of inter-personal communication. During the course, students will learn the proper method of speech preparation and effective delivery, as well as proper outlining, research techniques, and use of the library. A variety of speaking situations will be introduced including demonstration, informative, impromptu, extemporaneous, persuasive, oral interpretation, and reader's theater. Students will be given the opportunity to develop self-confidence and poise.

❖0752 Introduction to Computer Sciences

(Grades 9-12, 2 semesters, 1 credit)

Prerequisite: None

An interactive introductory course for students brand new to programming that teaches the foundations of computer science using the Python language. Not only will this semester- or year-long course prepare students for AP Computer Science A and AP Computer Science Principles, but it will teach students how to think computationally and solve complex problems, skills that are important for every student.

❖0754 Computer Science A - Java

(Grades 11-12, 2 semesters, 1 credit)

Prerequisites: No prior computer science knowledge/experience necessary; Algebra 1 required; Algebra II recommended. Dual Credit through Lincoln University

AP CSA is a full-year AP course geared towards 11th-12th graders who are serious about programming. Java requires a good mathematical background and strong problem-solving skills. The course will prepare students for the Advanced Placement Computer Science exam, level A. Students will learn to design and implement computer programs that solve problems relevant to today's society, including art, media, and engineering. AP Computer Science A teaches object oriented programming using the Java language and is meant to be the equivalent of a first semester, college-level course in computer science. It will emphasize problem-solving and algorithm development, and use hands-on experiences and examples so that students can apply programming tools and solve complex problems. Edhesive's AP Computer Science A is approved by the College Board as an authorized AP Computer Science A course.

Students enrolled are required to provide their own laptop. Laptop requirements:

Operating System: Windows: 2000, 2003, Vista, 7, 8 OR Mac: OS 10.4, 10.5, 10.6, 10.7, 10.8, 10.9

Audio: Sound card & headphone capability

Java: Java version 5 or later (Note: JDK is needed, not the JRE) -- Java 8 is preferred

0738 Life Skills for the 21st Century

(Grade 11-12; 1 semester, .5 credit)

Prerequisite: none

Life Skills for the 21st Century is the study and management of real-life skills for young adults. Topics include handling finances, character building, communication skills, time management, cooking/nutrition, house and car ownership and maintenance, and community involvement. This course will help prepare students for independent living, college, and the work world.

0748 Sports Medicine

(Grades 11-12; 1 semester; .5 credit)

Prerequisite: Biology

Sports Medicine examines the many aspects related to athletics, injuries, prevention, and medicine. It begins by exploring the history of sports medicine and the role of the athletic trainer. The course will examine the many kinds of athletic injuries and methods used to prevent injuries. Students will understand the anatomy and mechanism of injury for the most common areas in athletics, including the critically injured. Students will also learn taping and rehabilitation techniques for various athletic injuries. The class will utilize interactive discussions, lecture, and practical labs to master these sports medicine skills.

0752 Cadet Teaching

Cadet Teaching gives students the opportunity to assist and encourage students under the supervision of a classroom teacher. They will have the opportunity to observe and to develop knowledge, skills, attitudes and behaviors necessary to be successful in such a teaching career. This course satisfies the mentoring/tutoring hours necessary for the A+ program. An application is required and students are responsible for arranging their own transportation if they are assigned to a site outside of Helias.

❖Course is approved by the National College Athletic Association

SCIENCE DEPARTMENT

The Science Department focuses instruction so students will:

- Apply the scientific method to pose questions and generate solutions.
- Speak accurately about key concepts of the life and physical sciences.
- Relate scientific knowledge to societal, ecological, and political issues and how they relate to Catholic teaching.
- Collect and interpret scientific information.
- Use graphs and tables to answer questions and generate solutions.
- Use technology properly, such as the internet, to research scientific information and collect scientific data.

Other Information:

- All students are required to earn 3 credits in Science for graduation.
- The college bound student should take 4 credits in Science with at least 1 credit in a lab class.

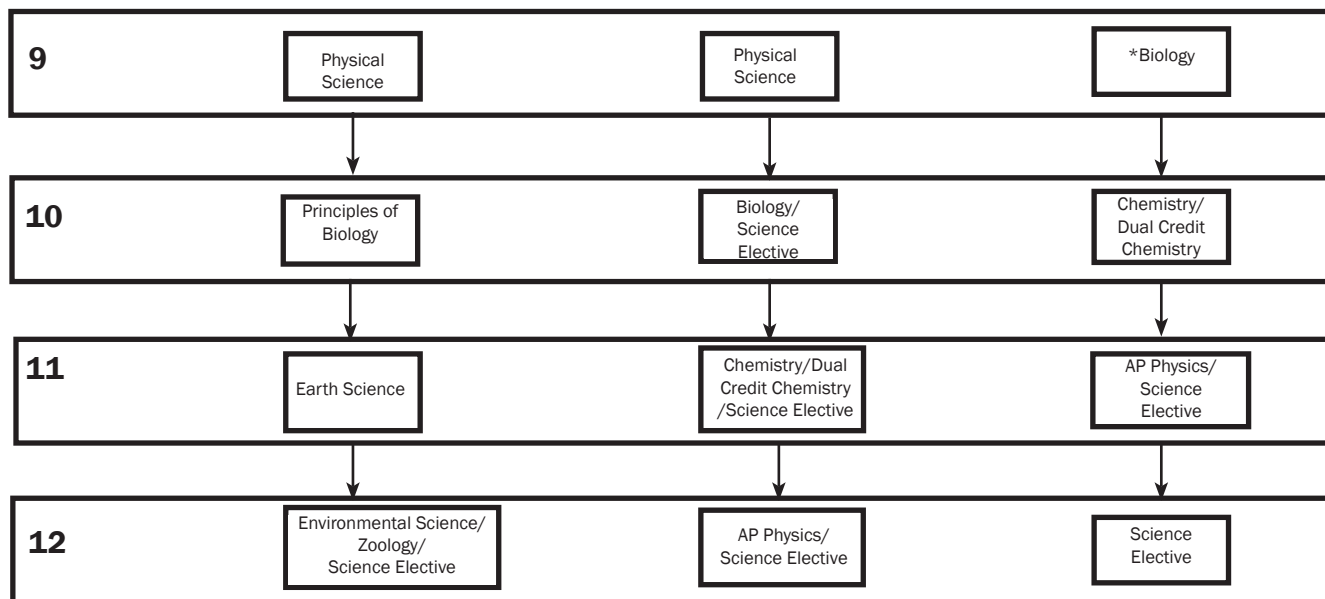

* In order to take Biology in 9th grade, students must earn an approved score on a placement test and earn at least a B in Algebra I in 8th grade.

Science Electives:

Anatomy & Physiology

AP Biology

Chemistry or Dual Credit Chemistry

Earth Science

Environmental Science -- Senior-level course, juniors may register if concurrently enrolled in another science class.

Zoology -- Senior-level course, juniors may register if concurrently enrolled in another science class.

❖0402 Physical Science

(Grade 9; 2 semesters; 1 credit)

Prerequisite: None

Physical science will cover the basics of physics and chemistry, including topics such as forces and motion, electricity, matter and energy, the periodic table, chemical reactions, and metric system conversions. The class is centered around hands-on learning and discussions. Throughout the course, the impact of science and technology on daily living is stressed. Laboratory work is included.

0404 Principles of Biology

(Grade 10; 2 Semesters; 1 credit)

Prerequisite: Physical Science

Principles of Biology is designed to provide the student with a study of living things on a more practical level. Topics included are use of the microscope, scientific method, study of the cell, nutrition, animal groups, genetics, natural selection, plants, ecology, and systems of the human body. There is a variety of laboratory work included for each topic.

❖0406 Biology

(Grade 9-12; 2 semesters; 1 credit)

Prerequisite: Physical Science.

Freshmen enrolling in Biology must obtain approval from the principal.

Biology is designed to provide the student with a detailed study of the scientific method, the cell, use of the microscope, systems of the body, animal phyla, internal structures of plants, heredity and genetics, natural selection, and ecology. There is a variety of laboratory work included for each topic. Biology is geared for the average to above-average student.

❖0412 Chemistry

(Grades 11-12; 2 semesters; 1 credit)

Prerequisite: Physical Science and C or above in Algebra I-A.

Lincoln Univ. math placement test with score of 33 or Math ACT score of 22 required.

Students are required to bring their own device.

Dual Credit through Lincoln University (2nd semester)

This course is a basic study of the fundamentals of inorganic and organic chemistry. For the student who will go on to college, this will be a strong foundation for further study of chemistry. The student who will take no more chemistry will receive a basic understanding of the world around them. The course is structured with lecture and laboratory work. Chemistry is offered as a dual credit course through Lincoln University (CHM 101/101L, 4 credit hours). Students may enroll in dual credit chemistry after successful completion of the first semester of chemistry.

❖0414 Dual Credit Chemistry

(Grades 11-12; 2 semesters; 1 credit)

Prerequisite: Physical Science and B or above in Algebra I-A

Lincoln Univ. math placement test with score of 33 or Math ACT score of 22 required.

Students are required to bring their own device.

Dual Credit through Lincoln University (1st and 2nd semester)

Dual Credit Chemistry covers the topics of Chemistry I more rapidly and in more depth. Additional topics covered include, but are not limited to, equilibria, kinetics, electrochemistry, nuclear chemistry, and thermodynamics. This course is intended for students majoring in a science and needing more than one semester of introductory chemistry. This is a flipped classroom course where students watch lecture videos at home. This class is driven by the laboratory component and higher order problem solving. Dual Credit Chemistry is offered as a dual credit course through Lincoln University both first and second semester (CHM 101/101L, 4 credit hours and CHM 102/102L, respectively). Each semester is 4 credit hours. Students wishing to take the AP exam will work through the second semester at an accelerated pace so they can prepare for the AP Chemistry exam in early May.

0408 Earth Science

(Grade 11-12; 2 semesters; 1 credit)

Prerequisite: Principles of Biology or Biology

Earth Science includes the examination of Earth, Earth processes and Earth resources including rocks and minerals. Topics are earthquakes, volcanoes, plate tectonics, glaciers, weather and space.

❖0420 Zoology

(Grade 11-12, 1 semester; .5 credit)

Prerequisite: Grade 12; or grade 11 with congruent enrollment in another 1-credit science class.

Zoology is a one semester course designed as a survey of the nine major phyla of the Kingdom Animalia. Course content focuses on morphology, taxonomy, anatomy and physiology of respective animals. The course includes laboratory observation and dissection of selected specimens.

❖0416 Environmental Science

(Grade 11-12; 1 semester; .5 credit)

Prerequisite: Prerequisite: must have previously completed or be enrolled in Chemistry or Earth Science

Are you a responsible steward of the Earth? Environmental Science is a laboratory science course that enables students to develop an understanding of the interrelationships within the natural world, to identify and analyze environmental problems both natural and man-made, to evaluate the relative risks associated with these problems, and to examine alternative solutions for resolving and/or preventing them. Students will explore environmental science concepts through an inquiry-based approach. Concepts explored in this course include: water and land resources, energy resources and consumption, pollution and waste issues, human population, earth systems, global change, and civic responsibility.

❖ 0410 Anatomy and Physiology

(Grades 11-12, 2 semesters, 1 credit)

Prerequisite: Completion of Biology and Physical Science

Anatomy and Physiology provides a more complete understanding of the basic principles of the human body and its functions. Students interested in professions such as nursing, physical therapy, physical education, pharmacy, and public health are introduced to concepts which will prepare them for further study in their chosen career. This course is an in-depth study of anatomy and physiology with emphasis on microbiology, structure and physiology, cellular structure and function, human anatomy and physiology, and current issues in medicine. The course will include lectures and laboratory work.

0418 Physics

(Grades 11-12; 2 semesters; 1 credit)

Prerequisite: Algebra II, College Algebra, or a strong recommendation from the Geometry Instructor.

Lincoln Univ. math placement test with score of 33 or Math ACT score of 22 required.

Students are required to bring their own laptop.

Dual enrollment through Lincoln University

Physics provides a basic study of the fundamentals of physics, presented over two semesters. It is designed to be an investigational course, combining theory and practical application through lectures, laboratories, and interactive demonstrations. Topics include mechanics, states of matter, waves and lights, electricity and magnetism, and modern physics. This course is designed to be less mathematically rigorous than AP Physics and would be especially useful for those with an interest in engineering, health and science related fields. Students will have the opportunity to take this course dual-enrollment through Lincoln University and earn 4 credit hours of dual credit for each semester.

❖0428 AP Physics

(Grade 12; 2 semesters; 1 credit)

Prerequisite: Pre-Calculus or strong recommendation from Algebra II-A Instructor.

Lincoln Univ. math placement test with score of 33 or Math ACT score of 22 required.

Students are required to bring their own laptop.

Dual enrollment through Lincoln University

This course provides an intensive, mathematically based study of the laws and principles that govern the universe. This course covers two-semester of college-level physics and is designed to prepare students interested in the fields of physics, engineering, and medicine. Emphasis is placed on problem-solving and critical thinking. Topics include: mechanics, thermodynamics, electromagnetism, light and optics, and modern physics. This course places strong emphasis on both lecture and laboratory components. Students who take this class will be well-prepared to take the AP Physics 1 test. Students who wish to take the AP Physics 2 or the AP Physics C (Calculus based physics) will require some independent study. Students will have the opportunity to take this course dual-enrollment through Lincoln University and earn college credit. Students will earn 4 hours of dual credit for each semester.

❖0422 AP Biology

(Grade 11-12, 2 semesters, 1 credit)

Prerequisite: Completion of Biology and Chemistry I with a “B” average or current enrollment in Chemistry.

Students are required to bring their own laptop.

Students must have an in-depth understanding of Biology and Chemistry. AP Biology requires advanced inquiry and reasoning skills, scientific inquiry, and connecting concepts across four big ideas. This course is designed to be the equivalent of a college-level introductory biology course. An emphasis is placed on biochemistry, genetics, plant and animal science, cell structure and function, evolution, and ecology. The course is structured with lectures and laboratory work. Students are able to take the AP Biology exam at the end of the school year.

SOCIAL STUDIES DEPARTMENT

The Social Studies Department focuses instruction so that students will:

- Demonstrate the ability to use geographical skills across the Social Studies curriculum.
- Critically analyze and explain contemporary political, social, and economic issues within the U.S. and abroad.
- Apply Catholic teachings and ethical analysis to current world events.
- Integrate the history and politics of Missouri into the Social Studies curriculum.
- Give examples of how the societal, cultural, and religious environment in which an individual lives helps to explain behavior and world view.

Other Information:

- All students are required to earn 3 credits in Social Studies for graduation, including Civics for .5 credit.

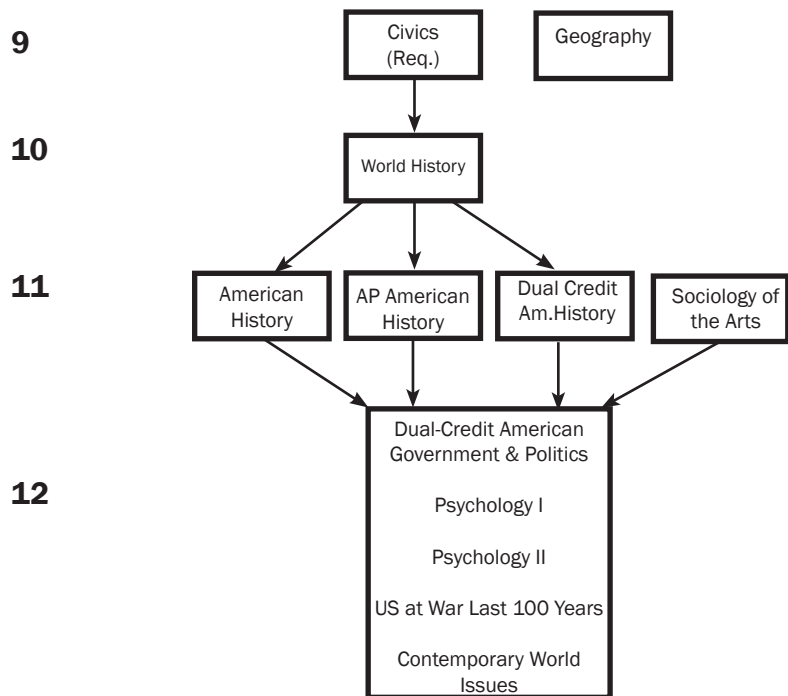

❖0502 Civics

(Grades 9; 1 semester; .5 credit)

Prerequisite: None

In Civics students learn a basic understanding of how American government on the federal, state, and local level is organized, how the institutions function, and the role of government officials. This course provides students with the education necessary to become informed participants in the civic affairs of their community. It includes a study of “Faithful Citizenship,” the teaching of the U.S. Catholic Bishops on responsible citizenship as a virtue and participation in political life as a moral obligation. **Missouri state statute requires class participants to take and pass a U.S. Constitution as well as a Missouri Constitution exam.**

❖0504 Geography

(Grades 9; 1 semester; .5 credit)

Prerequisite: None

In Geography students focus on the study of the Earth as well as the people who inhabit it. This course will help students review and develop map, globe, and interpretive skills used in the study of geography. Students will also become familiar with the five basic themes in geography: location, place, relationships within places, movement across the Earth’s surface, and regions. These themes will be applied to a study of the United States and selected regions of the world.

❖0506 World History

(Grades 10; 2 semesters; 1 credit)

Prerequisite: Civics

In World History students learn to understand and appreciate the roots, development, and nature of American-Western civilization, as well as other civilizations and cultural tradition of the world—namely those of Asia and Africa. This course will help students come to a better understanding of the world around them and enable them to comprehend contemporary problems within a global or international frame of reference.

❖0508 American History

(Grades 11; 2 semesters; 1 credit)

Prerequisite: Civics

In American History, students will trace the general development of the U.S. from the Age of Exploration to the 20th century. Areas emphasized will be Age of Exploration, Revolutionary Period, Civil War, development of the West, World Wars I and II, the Twenties and Depression, and post World War II America. Students will gain a broad appreciation for the diverse history of the United States in a global setting.

❖0522 The United States at War: The Last 100 Years

(Grade 12; 1 semester; .5 credit)

Prerequisite: Civics and American History

In the United States at War, students will study wars the U.S. has participated in over the last 100 years. Students will analyze the circumstances that lead nations into war and the effects these wars have on a global and local scale. It will include a study of the Catholic Church’s teachings on these wars and its presence within war-torn areas.

❖0514 Psychology I

(Grade 12; 1 semester; .5 credit)

Prerequisite: None

Psychology is the scientific study of behavior and mental processes. In this course, students explore the areas of memory, learning, motivation, biological bases of behavior, sensation and perception, altered states of consciousness, and child development. Emphasis is placed on the scientific nature of psychology as well as its personal applications. In order to understand the full range of psychological study, it is strongly suggested that Psychology I be followed by Psychology II.

❖0516 Psychology II

(Grade 12; 1 semester; .5 credit)

Prerequisite: Psychology I or the consent of the Instructor

In Psychology II, students continue their study of behavior and mental processes through the areas of adolescent and adult development, personality theories, psychological testing, social psychology, adjustment and breakdown, and human relations. Emphasis is again placed on the scientific nature of psychology, as well as its personal applications.

❖0512 AP American History

(Grade 11; 2 semesters; 1 credit)

Prerequisite: Sophomore English Instructor's signature or Counselor recommendation.

Must also have a 3.0 GPA or a GPA of at least 2.5 and parental consent to be considered.

Students are required to bring their own laptop.

AP American History is designed to provide advanced students with the skills and knowledge necessary to explore the issues and problems of American history. Upon completion of this course, students will be given the opportunity to take an exam for college credit and/or placement. Because the course is taught at a level equivalent to a freshman college survey course, strong reading and writing skills, as well as a high level of self-discipline and motivation, are essential. The course will follow a chronological study of American history from the early colonial period to the present. Emphasis will be on exposing students to a wide variety of historical material and interpretations in order to provide students with the following skills: to think critically and to write clearly; to read, analyze, and use primary and secondary sources; to form and test thoughtful hypotheses.

❖0510 Dual Credit American History

(Grade 11; 2 semesters; 1 credit, 6 credits from Lincoln University)

Prerequisite: Sophomore English Instructor's signature or Counselor recommendation.

Must also have a 3.0 GPA or a GPA of at least 2.5 and parental consent to be considered.

Students are required to bring their own laptop.

Dual Credit through Lincoln University.

Dual Credit American History is designed to provide advanced students with the skills and knowledge necessary to explore the issues and problems of American history. Upon completion and passage of this course students will receive college credit from Lincoln University. Because the course is taught at a level equivalent to a freshman college survey course, strong reading and writing skills, as well as a high level of self-discipline and motivation, are essential. The course will follow a chronological study of American history from the early colonial period to the present. Emphasis will be on exposing students to a wide variety of historical material and interpretations in order to provide students with the following skills: to think critically and to write clearly; to read, analyze, and use primary and secondary sources; to form and test thoughtful hypotheses.

❖0512 AP American Government and Politics

(Grades 12; 1 semester; .5 credit)

Prerequisite: Civics. Must also have a 3.0 GPA or higher to be considered.

This is an online class through Lincoln University. Students are required to bring their own laptop.

Dual Credit through Lincoln University

Dual Credit American National Government is designed to analyze the social, economic, political and historical trends in the politics and governmental operations of the United States and the world. Students will be better prepared to critically assess the current developments in the United States, world and state of Missouri.

This class will be an online class. All work will be done through Lincoln Canvas. Upon completion and passage of this course, students will receive college credit from Lincoln University. Students will be required to enroll in Lincoln Dual Credit and pay the necessary fee. Because this class is taught at a equivalent to a freshman college survey course, strong reading and writing skills, as well as a high level of self-discipline and motivation are essential.

❖0518 Contemporary World Issues

(Grades 12; 1 semester; .5 credit)

Prerequisite: None

Contemporary World Issues is an elective designed to focus on learning about and discussing world events and activities of the later 20th century and today. Using group discussion based on research done outside of class, reading of source materials, and completion of related assignments, the class will seek balanced historical explanations surrounding issues “In the News” or of interest to the class. The course goal is to provide a greater global awareness for today and the future.

❖ 0520 Sociology of the Arts

(Grades 11-12; 1 semester; .5 credit)

Prerequisite: Instructor’s signature required.

This course is designed to help students understand how changes in art, music, literature, media, fashion, science and technology reflect the social, political, and economic trends of each decade from 1920-1980. This is a project-based course. Information for projects is gathered through individual and group research, and through audio and video programs. It requires both independent and group work. Good time-management skills are necessary. This course could be either a Fine Arts or Social Studies credit.

THEOLOGY DEPARTMENT

The Theology Department focuses instruction so students will:

- Grow in their relationship with Jesus Christ so that they may come to know Him and live according to the truth He has given us.
- Appreciate that the Church is the living Body of Christ today and that, in and through the Church, they encounter Jesus Christ.
- Learn many forms of prayer as a means of growing in a deeper relationship with Jesus Christ.
- Learn how they can encounter Christ in a full and real way through the Sacraments, especially the Eucharist.
- Read, interpret, and apply Scripture to life.
- Use Scripture and the Catechism of the Catholic Church to defend and explain the teachings of the Catholic Church.
- Demonstrate an understanding of the relevance of the Apostolic Tradition of the Catholic Church throughout history.
- Understand and value the moral teachings of the Catholic Church to direct them in living a Christ-centered life.
- Explain how Christ's concern for others, especially the poor and needy, is present in the Catholic Church's social teaching and mission.
- Integrate the call of service, especially the preferential option for the poor, into their daily lives as an expression of closeness to Christ and neighbor.
- Explore vocational callings and consider the value of considering a vocation in service to the Christian community.

THEOLOGY DEPARTMENT

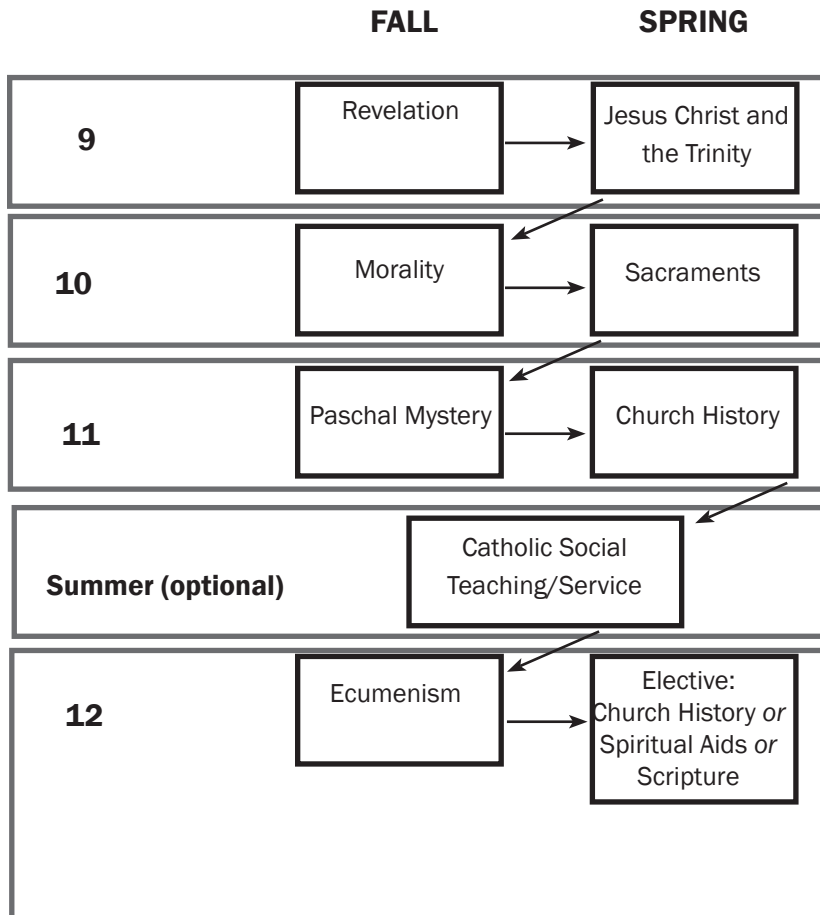

0102 Revelation of Jesus Christ (First Semester)

(Grade 9; 1 semester; .5 credit)

Prerequisite: None

Revelation of Jesus Christ gives students a general knowledge and appreciation of the Sacred Scriptures. Through their study of the Bible, students will encounter the living Word of God, Jesus Christ. Students will learn about the Bible, authored by God through inspiration, and its value to people throughout the world. They will learn how to read the Bible and become familiar with the major sections of the Bible, including the books in each section. The course will pay particular attention to the Gospels so students may grow to know and love Jesus Christ more personally.

0104 Jesus Christ and the Trinity (Second Semester)

(Grade 9; 1 semester; .5 credit)

Prerequisite: None

In Jesus Christ and the Trinity students are introduced to the mystery of Jesus Christ, the living Word of God, the Second Person of the Blessed Trinity. In this course, students will understand that Jesus Christ is the ultimate Revelation to us from God. In learning about who He is, the students will also learn who He calls them to be as children of God.

0108 Morality

(Grade 10 - First Semester; Grade 11 - Second Semester; 1 semester; .5 credit)

Prerequisite: None

In Morality, students will learn God gave humanity the Moral Law implicitly through the Natural Law as reflected in the Gold Rule expressed in numerous world religions and philosophies. In addition, students will gain an understanding that God gave an explicit expression of the Moral Law in the Ten Commandments and the Eight Beatitudes. Through study, students will discover it is only through Christ that they can fully live out God's plan for their lives. Students will learn the moral concepts and precepts that govern those who wish to live as disciples of Christ, which include: application of the Ten Commandments, Eight Beatitudes, and the Greatest Commandment to their lives; following the example set by Jesus Christ and the saints, understanding how to increase Theological and Cardinal Virtues within their lives, putting the Works of Mercy into action through service to their neighbor to demonstrate love of God.

0106 The Sacraments

(Grade 10 - Second Semester; Grade 11 - First Semester; 1 semester; .5 credit)

Prerequisite: None

In The Sacraments, students will learn that they can encounter Christ today in a full and real way in and through the Sacraments, especially through the Eucharist. Students will examine each of the Sacraments in detail so as to learn how they may encounter Christ throughout life.

0110 Church History (First Semester)

(Grade 12; 1 semester; .5 credit)

Prerequisite: None

Church History supplements and expands on what students learned in the sophomore course, The Church. They will be introduced to the fact that the Church was founded by Christ through the Apostles and is sustained by Him throughout history through the Holy Spirit. The students will come to know that the Church is the living Body of Christ today, and as such, both divine and human elements. In this course, students will learn about the Church's 2000 years of history and about how the Church is led and governed by the successors of the Apostles.

0114 Scripture (Second Semester)

(Grade 12; 1 semester; .5 credit)

Prerequisite: None

Scripture is an overview of Sacred Scripture with an introduction to the basic principles for understanding and interpreting the Bible. Because of the extent of the scriptural material, this outline will not try to cover the vast content but rather comments about Scripture's purpose and religious significance. Given the limits of a semester of study, it will not be possible to introduce all of the books of the Bible here. Every effort is made to show a sense of unity of the narrative for the divine plan of salvation, the presence of God's action in this record of His Revelation, and His desire to share His merciful love with us.

0116 Catholic Social Teaching/Service (Summer)

(Grade 12; 1 semester; .5 credit)

Prerequisite: None

Catholic Social Teaching/Service introduces students to the Church's social teaching. Students learn how Christ's concern for others, especially the poor and needy, is present today in the Church's social teaching and mission. Students will also serve as volunteers at school-approved agencies as part of this course.

0118 Spiritual Aids (Second Semester)

(Grade 12; 1 semester; .5 credit)

Prerequisite: None

The purpose of this course is to help students to understand the vocation of life: how Christ calls us to live in our everyday lives. In this course students will spend substantial time exploring our universal call to holiness and how this drives us to serve one another. We will also spend time exploring the traditional vocations of Marriage, Holy Orders and Consecrated Life. We will then end the course exploring our call for mission and evangelization. Part of the course will include hands-on opportunities to serve our Helias Community through Campus Ministry. This course will challenge the students to engage in an active prayer life, to live a life of service and to actively engage in discipleship and evangelization.

0112 Ecumenism (Second Semester)

(Grade 12; 1 semester; .5 credit)

Prerequisite: None

Ecumenism helps students understand the manner in which the Catholic Church relates to non-Catholic Christians as well as to other religions of the world. Building on the foundational truth that Jesus Christ established the Catholic Church and entrusted to her the fullness of God's revelation, the course is intended to help students recognize the ways in which important spiritual truths can also be found in non-Catholic Christian churches and ecclesial communities as well as in non-Christian religions. It is also intended to help them recognize the ways in which other systems of belief and practice differ from the Catholic faith.

NICHOLS CAREER CENTER

(Grades 11-12; 3 periods each day for 2 semesters)

The courses at Nichols Career Center are primarily meant for students who have a career goal directed toward employment or continuing education in a specific career and technical field. Students must be in good standing with credits and attendance prior to admittance into a Nichols program. Program slots are limited.

Programs offered: Auto Collision Technology, Automotive Technology, Building Trades I and II, Computer Technology, Culinary Arts, Electronics/Robotics, Graphic Communications, Health Sciences, Heating/Air Conditioning/Refrigeration, Welding, Agriculture Education (available grades 9-12 with approval), **Broadcast Journalism, Intro. to Agriculture and Foundations of Plants & Animals.**

Students who complete the following classes will receive the embedded credits listed. Please ask your counselor for more information on Nichols Courses.

Agriculture Courses – 1 science credit after 3 consecutive years (see counselor for more info.)

Automotive Collision Technology – .5 English and .5 Math credit each year

Auto Technology – .5 English and .5 Math credit each year

Broadcast Media – .5 English credit each year

Building Trades 1 & 2 – .5 English and .5 Math credit each year

Computer Technology - .5 English and .5 Math credit each year

Culinary Arts – .5 English credit each year

Graphic Communications - .5 English and .5 Math credit each year

Health Sciences - .5 English cred.edit each year

Mechatronics - .5 English and .5 Math credit each year

Welding - .5 English and .5 Math credit each year

DUAL CREDIT AND AP COURSES

Classes offered at Helias with Dual Credit or AP designation allow your student to earn college credit. All the classes listed are available as Dual Credit through Lincoln University. Only those listed as AP are available for AP exams and AP credit.

The difference between Dual Credit and AP credit :

Students in AP classes may choose to take an exam at the end of the class (in May), and based on their score on that exam, they can receive college credit that is recognized at nearly any college in the country. Scores range from 1-5, some colleges require a 4 or 5 for credit, others may require a 3. The cost of each AP exam is approximately \$100 and is incurred by the student.

Students in Dual Credit classes are basically enrolled in college courses while they are still in high school, allowing them to earn credit for both high school and college. Students will pay a reduced rate for the college credit (\$75 per credit hour in 2020) and those credits are usually accepted by most public universities and some private ones, but students and parents should always confirm acceptance of the credit with potential college choices before enrolling in the class.

HCHS COURSE NAME	AP Exam	LINCOLN UNIV. COURSE NAME
Computer Applications	NO	BED 208 Integrated Comp App.
AP English	YES	ENG 101 & 102 Composition and Rhetoric I & II
DC American History	NO	HIS 205 & 206 US History I & II
AP Physics	YES	PHY 101/101L & 102/102L College Physics I & II
Acc. Pre-Calculus	NO	MAT 121 Pre-Calculus Math
AP Calculus BC	YES	MAT 123 & 203 Calculus I & II
AP Calculus AB	YES	MAT 123 Calculus I
Chemistry	NO	CHM 101/101L General Chemistry
AP Chemistry	YES	CHM 101/101L & 102/102L General Chemistry I & II
DC Am. Government	NO	PSC 203 American National Government (online)
AP Spanish	YES	SPA 203 Intro to Spanish Comp.
AP Computer Science	YES	CS 101 Intro to Computer Science
Spanish III	NO	SP 205 Spanish II
AP US History	YES	N/A - No Dual Credit Available
AP Psychology	YES	N/A - No Dual Credit Available
AP French	YES	N/A - No Dual Credit Available
AP Latin	YES	N/A - No Dual Credit Available

ELIGIBILITY FOR AP/DUAL ENROLLMENT:

Please see the Helias website for information on eligibility for AP and Dual Credit courses.
www.heliascatholic.com

ADVANCED PLACEMENT EXAMS

AP exams are given the first two weeks of May each year.

For more information on AP/Dual Credit classes, please contact your student's counselor.

❖ Course is approved by the National College Athletic Association